

A' BRACKET

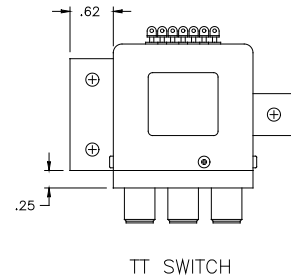

B' BRACKET

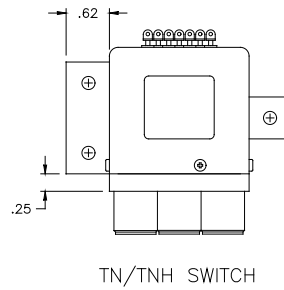
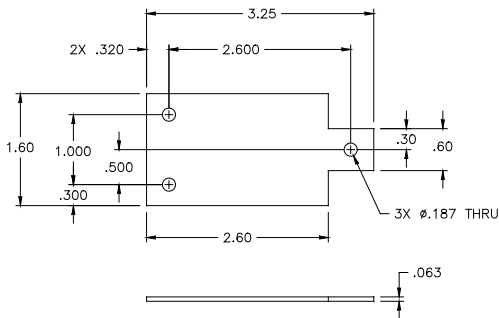
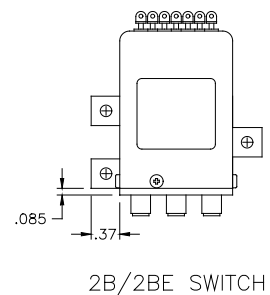
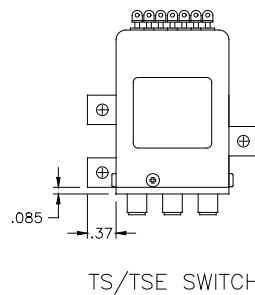
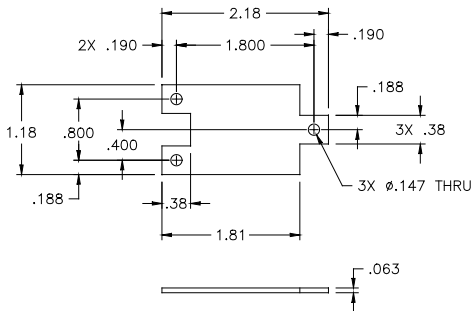

C' BRACKET

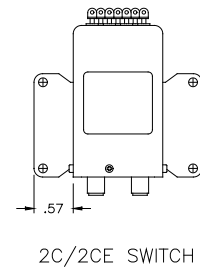
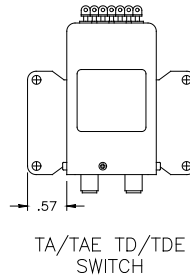
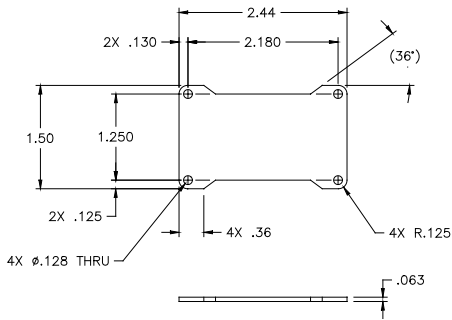

"D" BRACKET

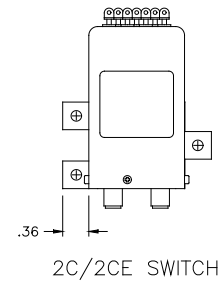
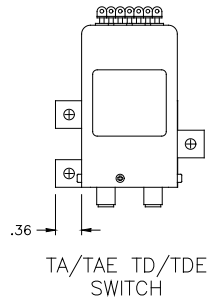
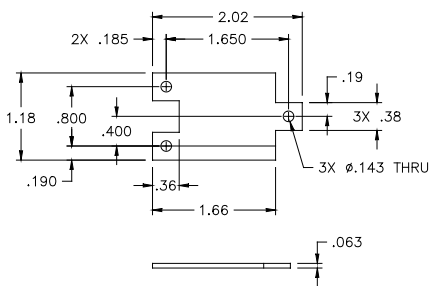

"E" BRACKET

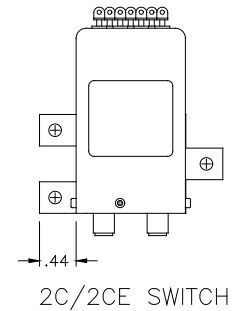
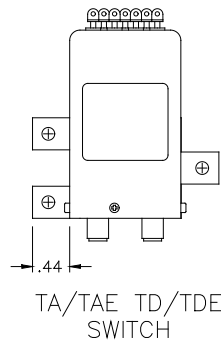
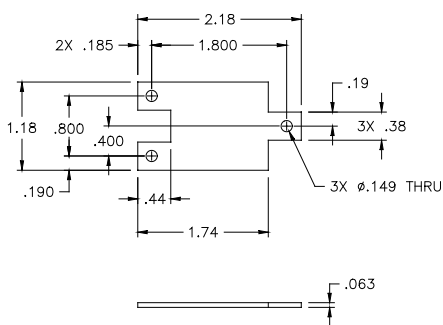

"F" BRACKET

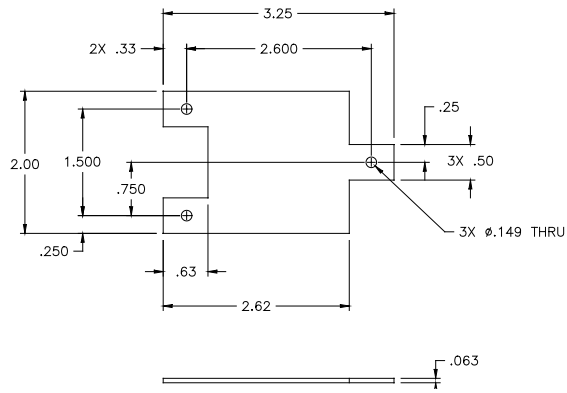

"G" BRACKET

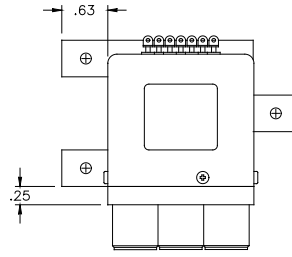

TN/TNH SWITCH

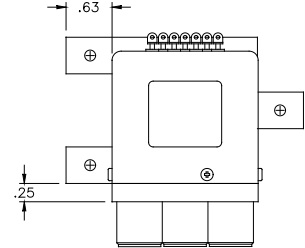

TT SWITCH

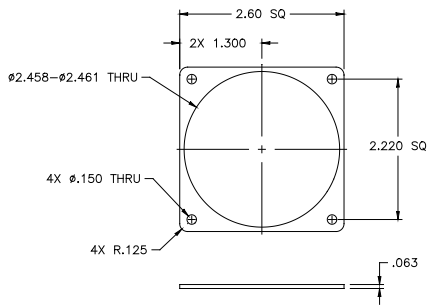

"H" BRACKET

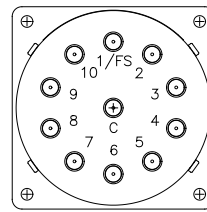

HS SWITCH

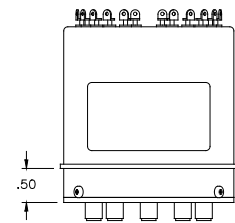

HS SWITCH

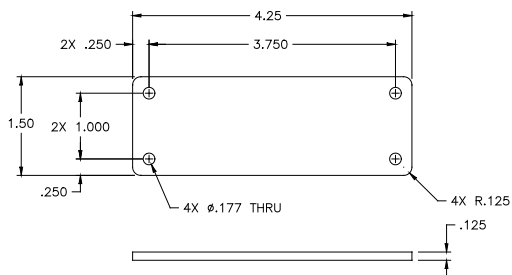

"J" BRACKET

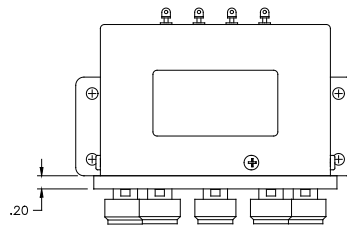

HN SWITCH

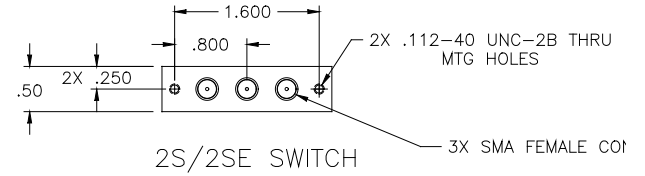
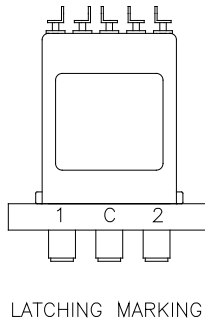
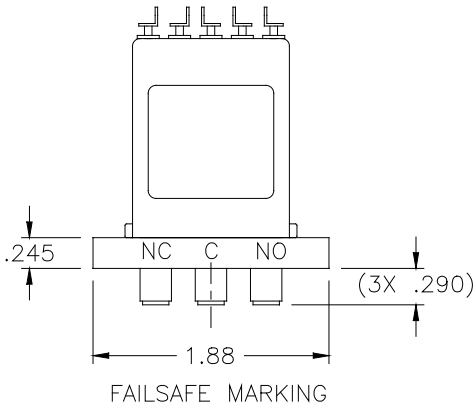

"R" BODY

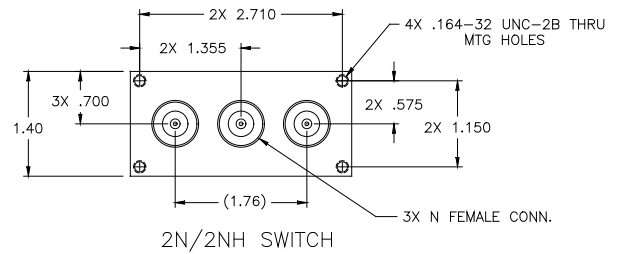
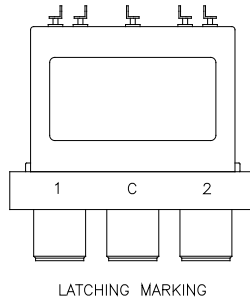
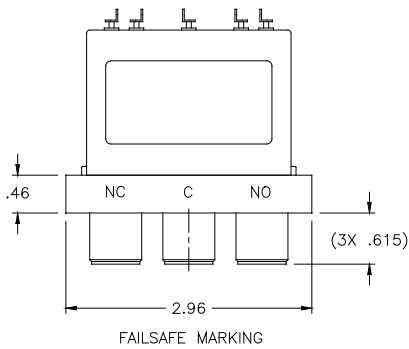

"S" BODY

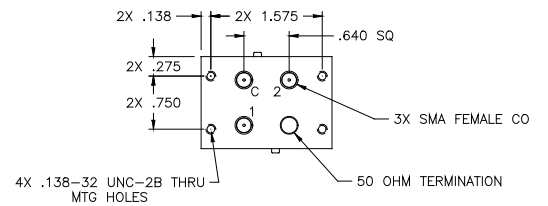
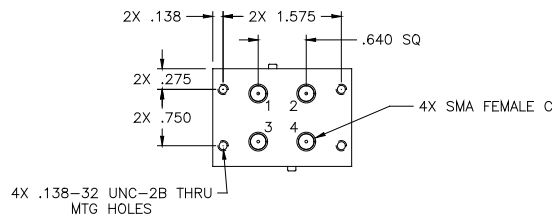
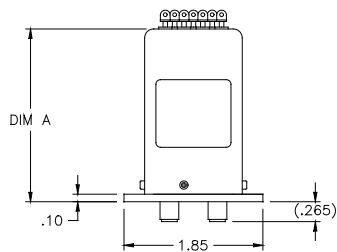

Consult Factory for Dimension "A"

"T" BODY

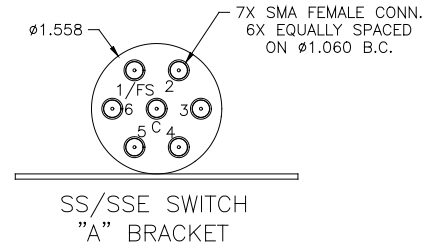
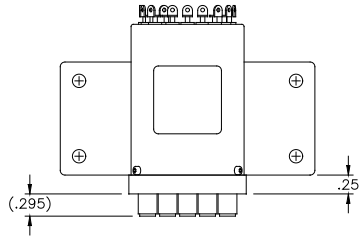

"U" BODY

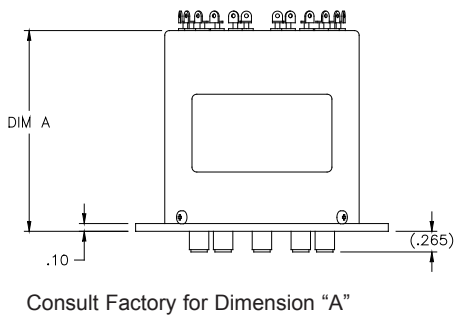

Consult Factory for Dimension "A"

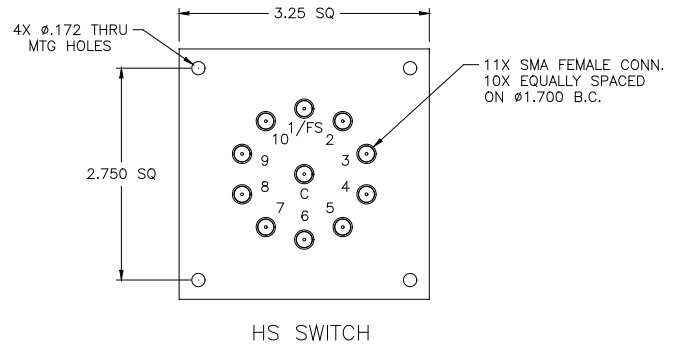

"V" BODY